

# Track formation improvement - problems, development and implementation: Part 1.

**In the first of a two-part article, Prof. Dr.-Ing. Klaus Lieberenz, em. Professor HTW Dresden, GEPRO Engineering Society Dresden, Germany, and Franz Piereeder, former Head of Track Maintenance Machine Operations, ÖBB Head Office, Linz, Austria, describe how the foundations and formation of the trackbed can affect the actual track quality and performance. Literary references (the bracketed numbers) will be detailed in the concluding part of the article.**

## Problems

The railway substructure is subjected to:

- Static and dynamic stresses resulting from rail traffic.
- Various climatic influences.

Under the influence of these stresses, the entire trackbed system and its individual layers, i.e. the substructure and the subsoil, is subjected to stresses and deformation [1]. Stresses must be assimilated by the given mechanical properties whereas deformations must not exceed certain limits. The elements of the trackbed system must be dimensioned so that the stresses acting on them can be absorbed without destruction or damaging deformations.

The deformations depend on the stresses acting on, and the resistances occurring in, the subsoil and the substructure which are determined by the layer densities and the deformation modulus of the soils and on the deformation modulus and thicknesses of the bearing layers installed [2]. The deformation modulus of the soils is dependent upon the water content and can, therefore, be influenced by drainage systems.

It is typical of railway lines that both the effects as well as the resistances fluctuate greatly and are dependent on the passing trains, on the speed, condition of the track and condition of the substructure influenced by weather and drainage. Damage occurs on the substructure when deformations are exceeded due to a lack of density, load-bearing strength, insulation against frost and filter stability. Soil failure often begins in the spring thawing period when there is a great rush of water and minimum load-bearing strength of critical soils.

The existing line network was built mainly in the 19th century under the limited technical capability of that time. Many problems that have to be solved today concerning maintenance and upgrading are a consequence of the earthworks 100 to 180 years ago and of the increase in loads that have developed since then. The only reaction to the rising loads and higher requirements, due to higher speeds and wheelset loads, has been through measures in the track. Under the action of its own load and traffic loads, the earthworks were usually compacted in the pressure area of the track and/or a consolidation or partial consolidation occurred so that a state of equilibrium came about.

In order to fully appreciate this, it is useful to have some knowledge of the conditions prevailing when the lines and

### Problems in the substructure

- Overloading  $\sigma_U < \sigma_{p,2} + \sigma_{p,2,dyn}$
- Reduced load-bearing capacity (inadequate drainage, loss of formation crossfall)  $\sigma_U^* < \sigma_{p,2}$

higher elastic and plastic deformations



Fig. 1: Loss of load-bearing capacity in the track at a wet bed.

loss of formation crossfall  
increased water content  
mixed zone  
loss of load-bearing capacity

earthworks were built in the 19th century. Informative sources used here were especially the books published in Vienna in 1876 by W. Heyne 'Der Erdbau in seiner Anwendung' [3] and by F. Rziha 'Eisenbahn-Unter- und Oberbau' [4]. The three books by Rziha give an interesting overview of the exhibits relating to railway engineering shown at the Vienna World Exhibition in 1873.

## The history of track and earthwork construction

The major part of the existing railway lines in Europe is built on earthworks on embankments, in cuttings or cuttings on a hillside or laid out to follow the topography. In the existing line network these tracks are up to 97% of the line length depending on the layout as level line or mountain railway. On mountain railways the track was laid with the aim of mass equalisation and on flat ground with a slight embankment to ensure adequate drainage. Earthworks were described as 'structures composed of natural materials, without special treatment, produced by ordinary labourers'. The goal was defined as follows 'to lift a clod of earth from one spot

and lay it down on another' [3]. Nevertheless, the earthwork had great importance from the beginning, because it was recognised early on that it incurs considerable costs for line construction (up to 65% of the total costs) and an irrational layout and design can compromise the entire construction.

There are different constructions of an earthwork:

- Reclaiming or producing earth.
- Securing the earth structure.
- Shifting or displacement of soil.
- Supply of soil masses or filling.

The cross-sections in Figure 2 illustrate the geometry of the earthworks from the beginnings of the railway. The formation width of a double track line was around 6.80 metres, the embankment slope 1:1.25 to 1:1.5 and the ditch depth around 0.56 metres.

Loosening and loading of the soils was done by hand, using spades, shovels, picks, hammers and chisels in various regional designs as tools (Figure 3). Solid sections of rock were blasted. The loosened soils were loaded using projection. For the removal of soils when working in cuttings, a system evolved on the continent to apply from

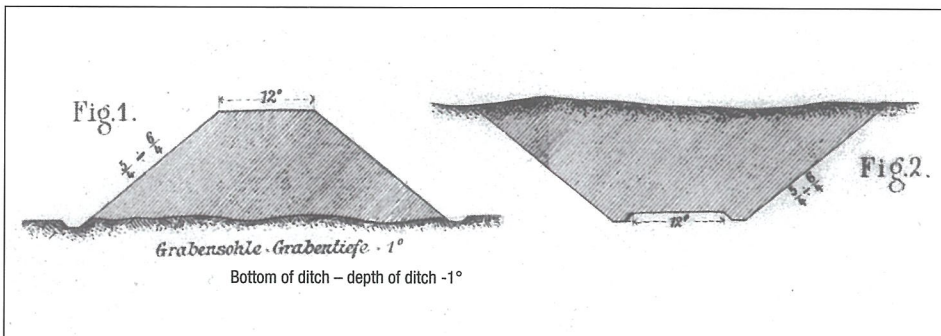
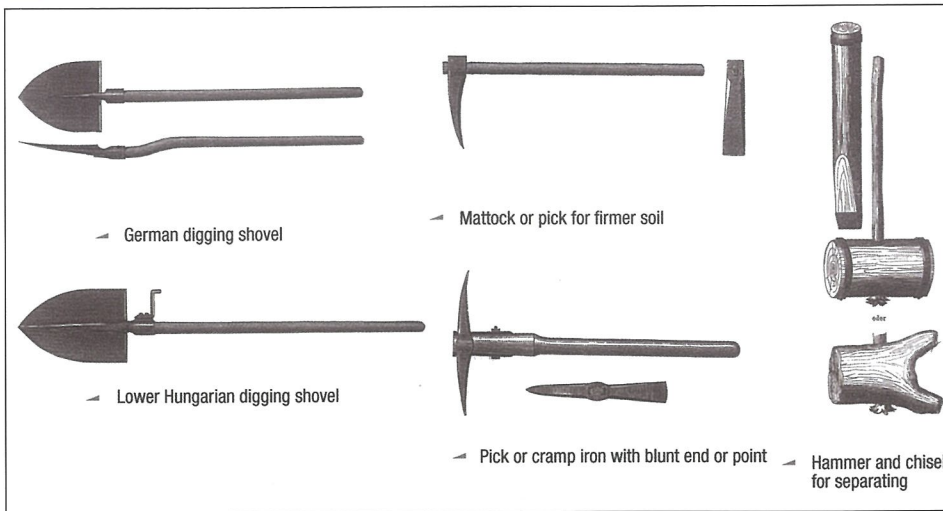

Fig. 2: Railway earthwork profiles (embankments and cuttings) on the Leipzig-Dresden Railway, 1836 to 1838. Taken from: Civil Engineer 1889.





Above: Fig. 3: Work tools for separating earth material from the ground and making into transportable and manageable sizes.

Below: Fig. 4: Means of transport for material on soil, wooden tracks and rail tracks, using workers, horses and locomotives.

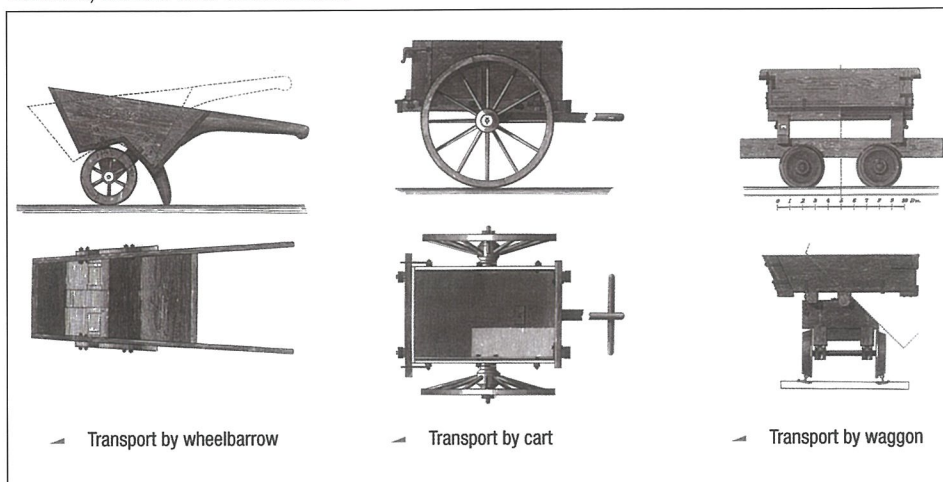

the starting and/or end point to achieve layered, lateral or head structures.

Transportation to the insertion area was initially carried out using wheelbarrows or carts (Figure 4) pushed or pulled by workers on the ground or on timber roadways. Figure 5 shows how such work was performed during

preliminary excavations to the Oberau Tunnel on the Leipzig–Dresden line close to Dresden. Later, horses were used for transport by horse carts and carriages on wooden tracks or rails. For rationalisation, tracks and locomotives were soon used for rolling wagon transport.

Placement of the earth masses for

constructing embankments was carried out in layered segment construction, head construction or scaffold construction (Figure 6) and the soil was usually placed directly after excavation without any regulation. Frequently, wooden filling scaffolds were used, like on the Weimar-Gera line in 1875 (Figure 7), leaving the supports in the embankment.

From today's point of view, the consolidation of the installed soils was completely inadequate although the goal was 'to implement the filling in such a way that the embankment obtains the greatest possible firmness' [3]. No consolidation was possible at all in the case of head construction and scaffold construction. With layered segment construction this was achieved by manual pounding and by the work machine traffic. When using coarse construction material, the cavities were specifically filled with finer earth. With cohesive types of soil, the lumps were broken down at the place of insertion, installed with a small layer depth of up to 30cm and compacted by manual pounding performed by strong labourers using wooden tampers. The advantage of alternating from loam or clay with sand layers was soon recognised. A slight over-pounding was intended primarily to push some of the sand into the empty cavities. Due to the manual pounding, less permeable layers were produced in the construction so this method was widely abandoned after some cases of damage. In order to reduce the settlements under traffic, time was often allowed for natural settlement of the embankments and/or accelerated through a superimposed earth fill due to the dead weight of the soil (Figure 8). However, the decisive consolidation was left to the factor time and this occurred during construction operations and under train load after resumption of services. In the course of time the load settlements led to an increase in the structural density of the soils installed.

Work on the track substructure was completed with the construction of the consolidated formation with crossfall. A fitting statement on the formation crossfall is given in



Fig. 5: Earth transport on wooden tracks during the construction of the first railway tunnel near Oberau which was built by Freiberg miners between 1837-1839.

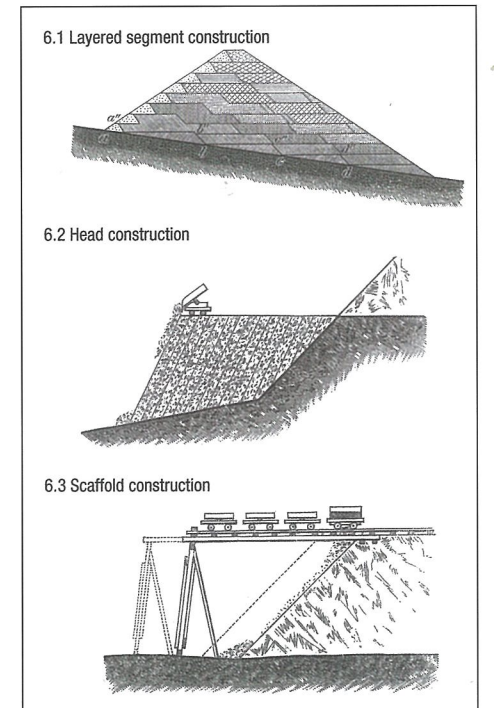

Fig. 6: Earthwork construction methods.



[5]: 'A dry railway crown is of the greatest importance for good construction and maintenance of the track. The surface water penetrating the ballast bed must be kept away from the substructure in order to prevent softening and freezing spots (frost heaves). Therefore, the formation on open lines is given a lateral slope of 1:20 to 1:30.' The track ditches on both sides should serve 'to drain away the surface water, to remove the groundwater and source water and, therefore, to keep the subgrade dry'.

Normally, the ballast bed materials were laid directly on the earth formation of the embankment or the cutting. Initially, the sleepers were bedded directly in gravels and sands, but it was soon recognised that the bedding should be as water permeable, resistant and elastic as possible. Later, the preferred ballast bed materials were good gravels such as river gravels or broken stone ballast, such as coarse crushed slag made of basalt, quartzite, diorite, gray wacke and porphyry were used. Depending on loading and type of line, the ballast thickness under the lower edge of the sleeper was between 10cm and 20cm, later up to 30cm. On yielding, wet subsoil, the thickness of the ballast bed had to be increased or a hard core reinforcement inserted to ensure a firm subsoil. Ballast bed and hard core reinforcement should be well drained to the sides and below.

If weak soils were adjoining, e.g. in loam or clay cuttings, the subsoil was strengthened with a hard core base made of broken stone or using gravel, river ballast or pit ballast. For the hard core base, the broken stones were laid manually on the high side with the wide surface downwards and with the point turned upwards. The surface had to be levelled, pressing out the cavities. Figure 9 shows types of construction and an example of installation on the Brenner railway line. Even today, sections of hard core reinforcement are still found in good quality during construction work and soil probing.

For the main part, construction was carried out over the subsoil without improvement. In special cases 'extraordinary substructures' were built using wooden stakes, stone fillings or fascines. Mechanisation of the earth construction works became possible from around 1860 with the development of mechanical engineering. In 1870, mechanical digging work was still irrelevant. However, when wages began to rise, the development of machine operation became economical and of interest.

Initially, ploughs were used to loosen the earth, whilst from 1860 the first machines for taking up and lifting the soils were used. In



Above: Fig. 7: Scaffold construction of an embankment on the Weimar to Gera line around 1875.

Below: Fig. 8: Consolidation by earth fill.

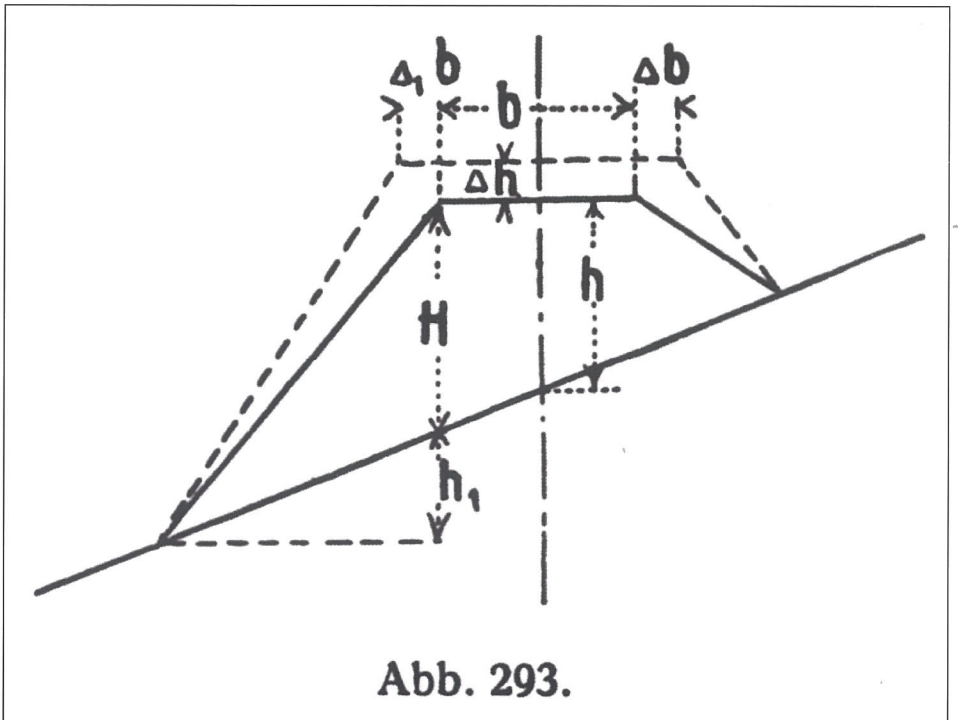

1871 the first excavator operated by Rziha worked in earthwork construction on a railway line in Hungary. To consolidate the soils, firstly horse-drawn smoothing rollers and sheepsfoot rollers were used, whilst from 1862 the first steamrollers were available and from 1902 the first motorised rollers.

### Load increase and operating experience

At first, the insufficient consolidation was not very problematic and the engineers learned to cope with the necessary load settlements at the low speeds. In earlier times, packing hoes and tamping picks made of wood and steel were used to perform the necessary tamping of the sleepers to correct and restore the track geometry. Due to the increasing demand for transport, many lines were upgraded to double-track lines by laying a second track by mechanical operation. This can often be recognised due to the very different substructure conditions in the cross-section of double-track and multiple-track lines.

In the following years, travelling speeds and wheelset loads rose continually. Figure 10 from [1] shows that from 1835 to 1910 wheelset loads rose from 2 tonnes to 14

Fig. 9: Early formation strengthening.

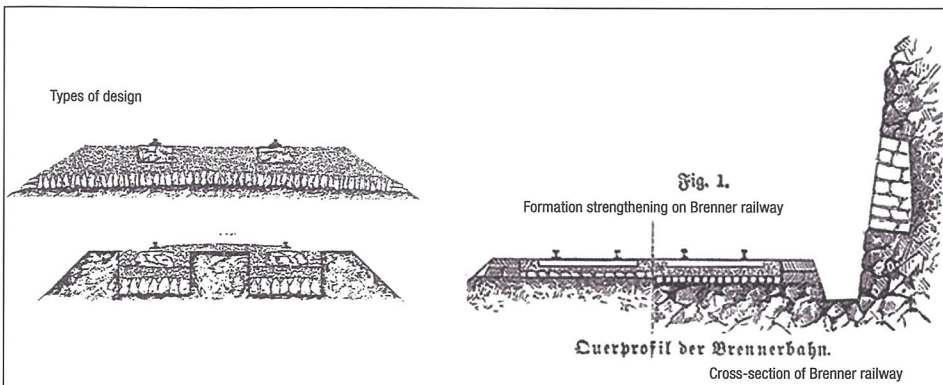



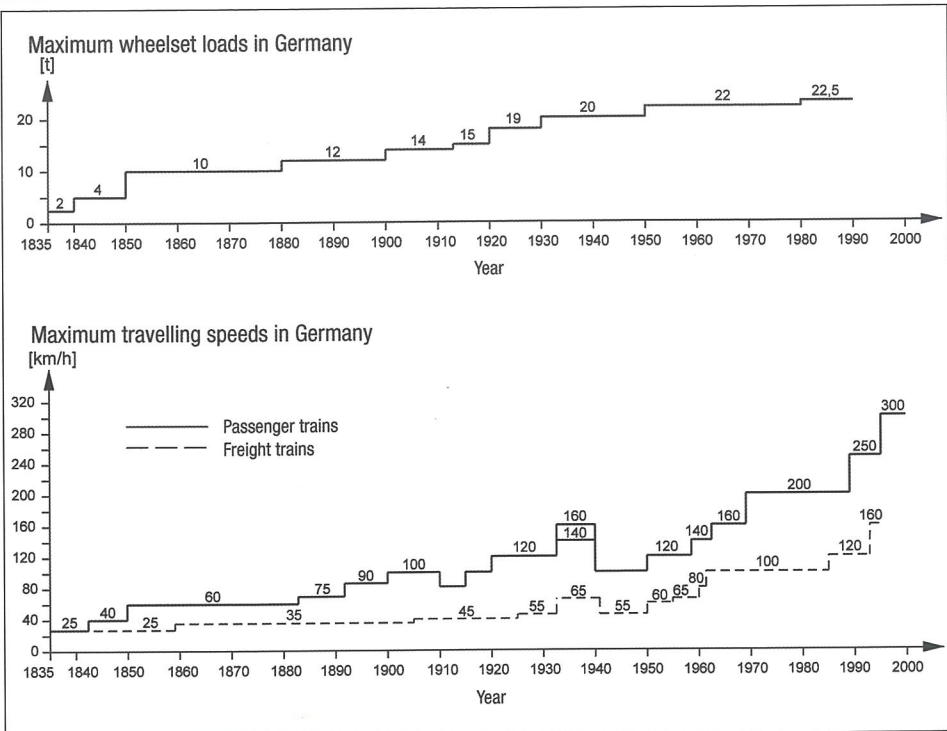

Above: Fig. 10: Increase of wheelset loads and travelling speeds.

Below: Fig. 11: The process in the development of wet beds.

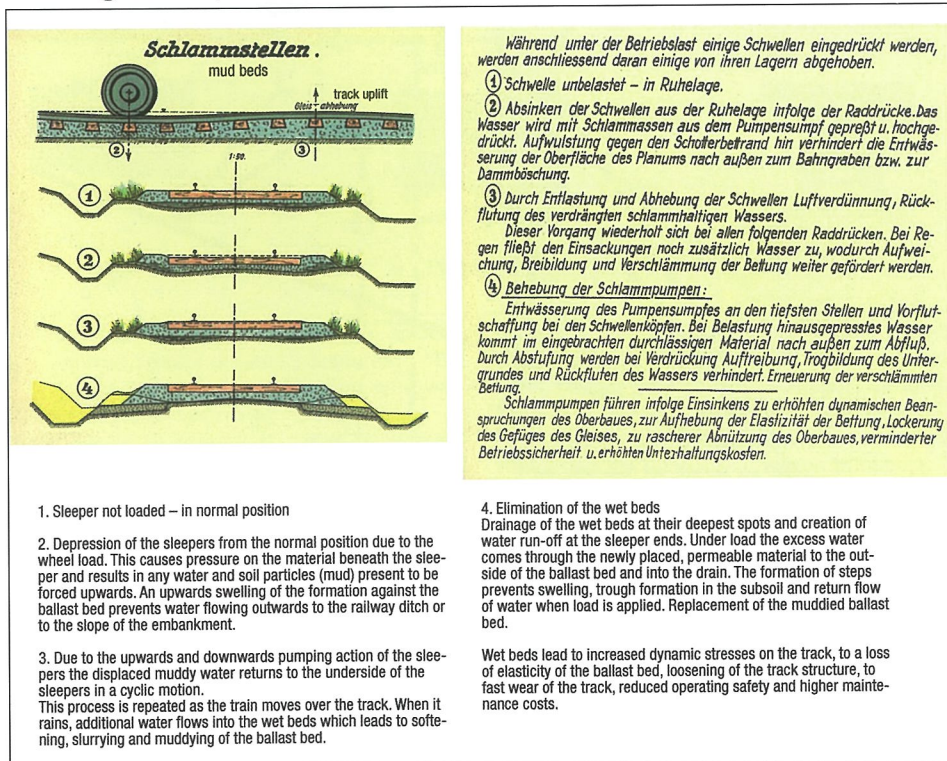

tonnes and travelling speeds from 25 to 100km/h. This led to greater stresses in the trackbed system and especially to deformations and bearing strength damage in

the track substructure and the subsoil. The plastic deformations as load settlements caused a subsequent consolidation in the pressure area of the track up to around 1.50

metres below the lower edge of the rail and a partial consolidation with a limited sufficient state of equilibrium. Under the elastic deformations and with critical saturation, small hollows formed in the formation with bordering cohesive soil in which water collected. The pumping action as vehicles passed over then produces mud which penetrates into the ballast and leads to mud clogging in the ballast bed. The bearing-load capacity damage as frost damage was recognised as particularly critical on soils with rising capillary water. Figure 11 from [6] shows the occurrence of mud spots and their remedy in characteristic situations and recognises waterlogging as critical. The response to problems in the foundation/subsoil was logically to apply measures to drain, but also to reinforce the track. In 1911, details were given in [5] under 'maintenance/improvement' about the improvement and reinforcement of the track. Also under 'ballast bed' the drainage was included and implemented so that 'maintenance of the ballast bed also extended to maintenance of the drainage, cleaning of the culverts and seepage channels, removal of the muddled section of the ballast bed and clearance of the vegetation'. Therefore, proper drainage was recognised as decisive for the load-bearing strength and frost protection of the soils and always demanded but only implemented in part. With larger problems the ballast thickness was increased, an additional lower layer was built of broken stones or a seepage channel was installed under the ballast bed initially as a remedy crossways and/or longitudinally. It was only much later that a layer of sand, gravel-sand or coke ash was tried out as a filter.

Figure 12 shows the drainage in a cutting situation using a seepage channel in combination with a filter layer made of coke ash. This was the beginning of the improvement and strengthening of the substructure using separate trackbed layers and/or formation protective layers.

Additionally, modified clearance gauges arising from the development of vehicles for greater transport tasks led to modified and above all wider line cross-sections. In 1904, the formation width of a double-track line was 9.28 metres (Figure 13) compared to around 6.80 metres as shown in Figure 2. In many cases the formation was widened not in compliance with the requirements using only uncontrolled fillings, therefore restricting the cesses and the drainage systems. This led to the hindrance of water drainage and consequently to critical hydrological conditions with a further increase in bearing-load capacity problems and frost problems.

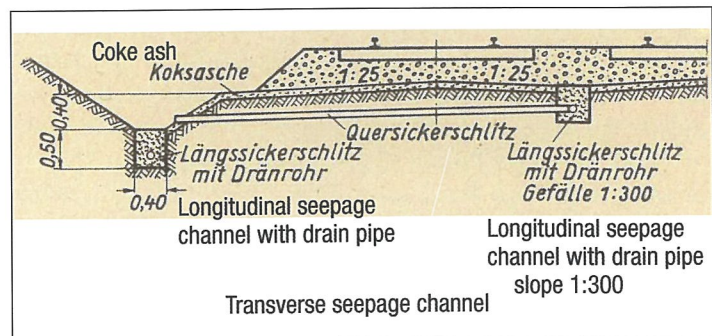

Fig. 12: Filter layer and drainage channel from 1890.

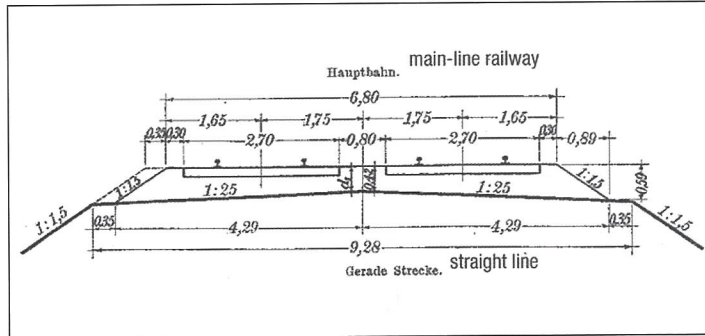

Fig. 13: Ballast bed cross-section for double-track lines in 1904.



# Track formation improvement - problems, development and implementation: Part 2.

This article is continued from Rail Infrastructure Issue No: 86. Prof. Dr.-Ing. Klaus Lieberenz, em. Professor HTW Dresden, GEPRO Engineering Society Dresden, Germany, and Franz Piereeder, Former Head of Track Maintenance Machine Operations, ÖBB Head Office, Linz, Austria, describe how the foundations and formation of the trackbed can affect the actual track quality and performance. Literary references (the bracketed numbers) are detailed at the end of the article.

## Development of track formation improvement

By the end of the 19th century deficiencies in the substructure were already starting to show and they were attributed mainly to the effect of water and frost. The regulations of the Bavarian Ministry from 1907 for the construction and maintenance of the railway track [8] can serve as a summary of the experience made in those times. They recommend for maintenance to dig the railway ditches deeper, to reinforce the ballast bed, to place a layer of sand under the ballast bed or to use a double layer ballast bed with the lower layer consisting of broken stones. Usually, thin layers of separating and filter layer sand, differing from region to region, were placed under the ballast bed consisting of uniform grain sands with a particle size of 0.06 to 2mm. The measures were carried out in sections by very arduous manual labour, placing the sand on the existing ballast bed and, by forking the ballast, the sand fell through on to the formation and was distributed.

In 1935, it was ascertained by K. Gunther (quoted in [7]) that a good subsoil with a functioning draining improves the quality and efficiency of the track threefold.

Fig. 14: Formation improvement according to Pfahl [6].

'The formation can be kept dry ... by proper drainage of the surface water by means of seepage und drainage systems, by preventing the rising of ground water and swelling of soft soil by the installation of insulating layers. These serve to break the capillarity and prevent any rising of water during frost and also, due to their heat insulation, they make it difficult for frost to penetrate.' Materials used for insulating layers were sand, brushwood, peat, tar, bitumen, cement and metal. The latter were prone to cracks and, therefore, did not achieve the desired effect.

In Austria, K. Pfahl was a visionary in the field of substructure and track. In the period from 1940 to 1945, he published a track maintenance guide 'Die Bahnerhaltung' [6] with many illustrations. Based on fitting analyses of the deficiencies and types of damage (Figure 11), he demonstrated many practicable solutions. These include the preferred drainage in the sleeper-end and cess area (Figure 14), the installation of layers consisting of sand, coal slag, brushwood and fascines as well as the drainage of ballast sacks (Figure 11). These jobs still had to be performed by arduous manual work and in the track in service. There was also a lack of sufficient consolidation and suitable stone mixtures. Due to insufficient filter stability, the drain pipes and drainage systems were clogged up with mud after a few years and needed cleaning which was a difficult job.

R. Raab summarises in [7] that the installation of hard core layers, stones, grit layers, sands, coarse coal slags as well as brushwood and peat did not bring the expected success because these materials had 'too many cavities that were too big'. More by accident, it was recognised that old ballast bed gravel-sand, which was initially mainly used as ballast bed material, slightly

mixed with loamy soil from the subsoil and/or so-called 'dirty ballast' made up of ballast particles, stone fines and loam had a well suited particle composition. If these old ballast bed layers and/or old sand layers were left in the track and the track was lifted appropriately, the formation improvement was successful in combination with well-functioning drainage systems.

During the Second World War and in the following years, scant attention was paid to specific maintenance, especially on the substructure, and later there was more focus on the further development of track designs. As a result there was a rise in deficiencies and damage, so increasingly the substructure was given more attention and from 1954 progressive experiences with measures undertaken on the substructure were published again [7]. Recommendations were given for the type and composition of protective layers between formation and ballast bed and their grain distribution. R. Raab formulated the following conditions for a so-called Formation Protective Layer (FPL):

- It must prevent fine particles of loamy and clay earth from rising up.
- It must prevent precipitation water from seeping on to the subgrade.
- It must achieve inner stability and friction to form a strong bearing plate that remains sealed and closes cracks when there is movement of the subsoil.
- It must not have any capillary properties in order to prevent frost damage.

In 1957 the following intensive investigation of the topics of drainage and protective layers led to the publication of the Earthworks Guideline DV 836 [8]. This presented the protective layer as a fundamental element for the assurance of load-bearing capacity and frost protection, for the prevention of mixing and for the

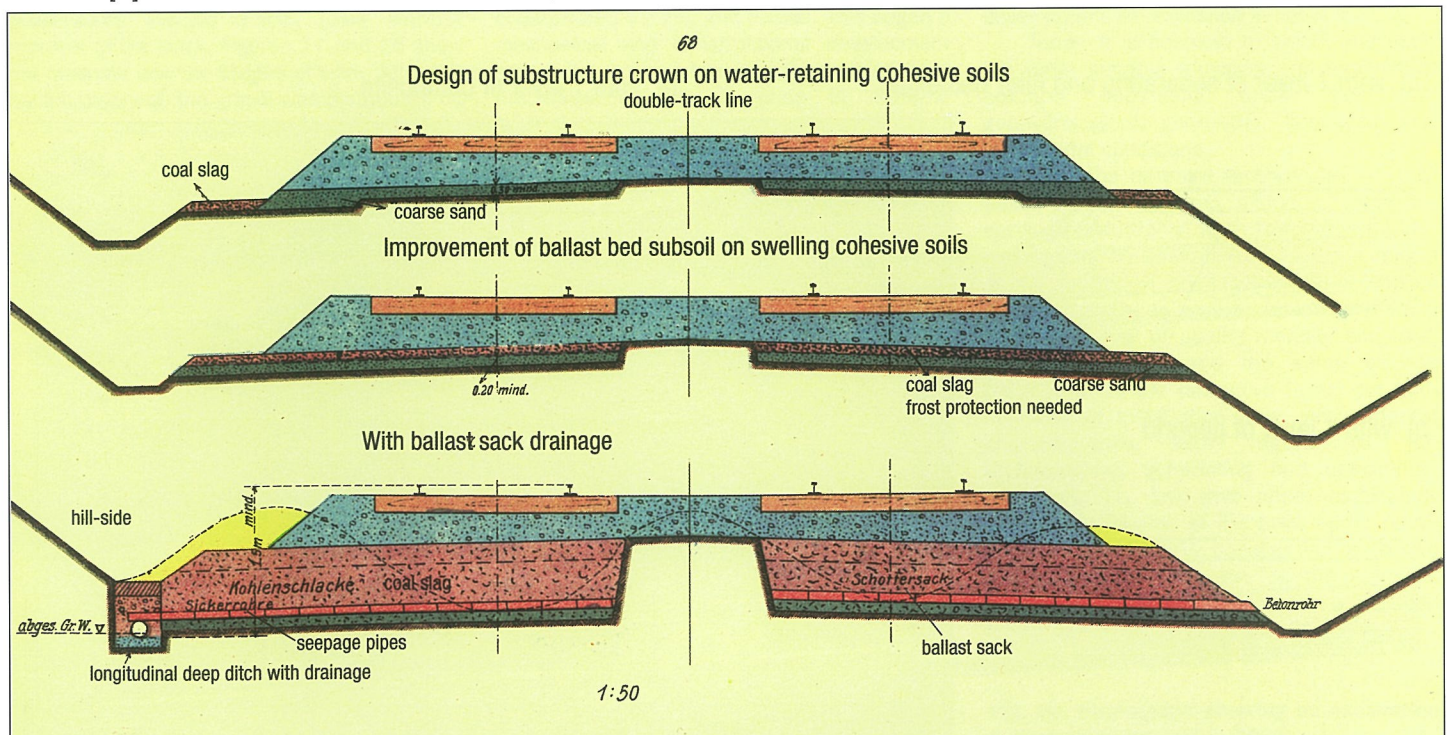

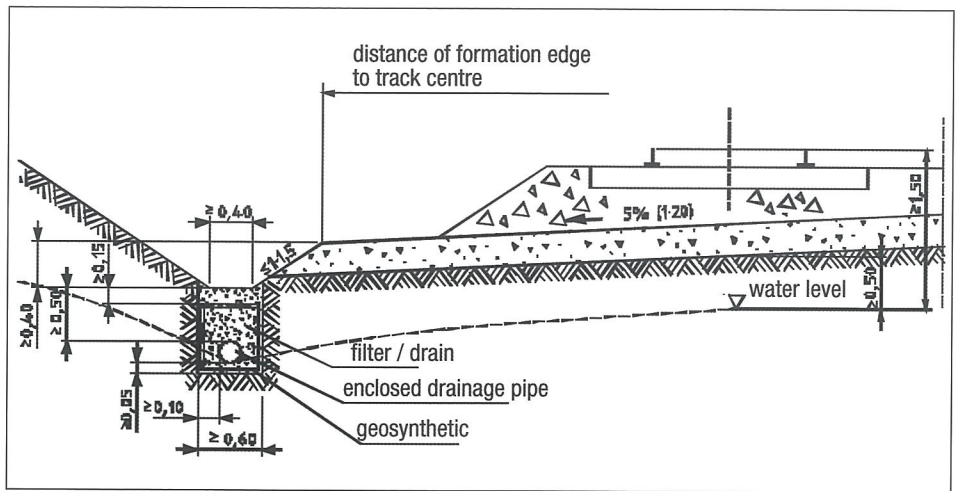

**Fig. 15: Cross section of a trackbed formation with drainage and protective layer.**

draining-off of surface water on the FPL and named it as a standard solution. The stone composition of the protective layer material is laid down in tight limits in Annex 1 of DV 836. The continuation of the Guideline was made after further basic work in stages up to the DS 836, the regulation for earthworks dated 01.01.1985 [9]. This was complemented with additional Technical Terms of Supply (TL 918 062) for the quality requirements to be met by mineral mixtures to be used as protective layer material. This meant that at DB a protective layer material was preferred which has a lower water permeability due to an increased proportion of fine grains and should, therefore, guarantee to a large extent the flow-off of the surface water on its surface. This concept led to high-quality protective layers, but also to an over-emphasis of the protective layer and, therefore, to less attention being given to the drainage systems.

At ÖBB, based on the experience made by K. Pfahnl, a more water permeable FPL was preferred and greater attention was given to the drainage which was recognised to be decisive for the load-bearing capacity and frost protection. This also corresponded with the development at Deutsche Reichsbahn (East German Railways) up to 1990 which was laid down in the Fachbereichsstandard Eisenbahnunterbau [10]. After the political changeover it was then permitted, under the terms of implementation (ABest) to the DS 836 [11] and the Guideline 836 dated 20.12.1999 [12], that besides the less water impermeable grain mixture 1 to also use the more water impermeable grain mixture 2 so that it was now possible to choose more selectively according to the locally available hydrological and geological conditions.

Today's state-of-the-art for track formation improvement is a combination of measures for drainage and the installation of trackbed layers and/or protective layers (Figure 15). Drainage measures are a reliable



means of preventing the retention of water due to water accumulation in the soil and, therefore, a critical rise in the water content with changes in consistency and loss of load-bearing capacity. On the track formation, the crossfall, open railway ditches, catchment channels and associated draining systems perform the tasks of collecting and drawing off the surface water.

Subsurface drainage systems are installed as an underground drainage system to collect and draw off unbound water from the soil and stratum water. Given their delayed effect, drainage systems should always be constructed before the installation of protective layers and/or before track renewal work.

Trackbed layers and/or protective layers are a layer system placed on the formation that protects the bordering soil from detrimental deformations and the effects of frost. They are laid as a trackbed layer, frost protective layer, separating layer, filter layer and sealing layer. They are made up of grain mixtures and can be added to or improved in their effectiveness by additional measures such as geotextile layers, transition layers or soil improvement layers. The layers can be installed when there is no track or using on-track machines.

These additional measures such as geosynthetics, sealing blankets, insulating slabs, sub-ballast mats and binding additives [1] were developed from 1973 so that it is possible to react in a more variable way to local conditions. These methods can achieve additional or increased separating, filtering, draining, reinforcing, sealing or dampening effects (Figure 16). In the meantime, trackbed systems have been developed which can perform many other tasks (see later).

### Laying technologies for formation protective layers

The initial manual insertion of formation protective layers consisting of gravel sands, using the block method without removal of the track or in open construction with removal of the track, was very labour-intensive and cost-intensive. The increasing use of construction machines and vehicles for installation without track soon replaced the manual labour. To perform this work, the section of track is closed in order to remove track, ballast bed and damaged subsoil and then place the new formation protective layer and ballast bed.

**Fig. 16: Examples of protective layers by the use of geosynthetics.**

### Protective layers with geosynthetics

a) with 1 layer of separating and filter geotextile

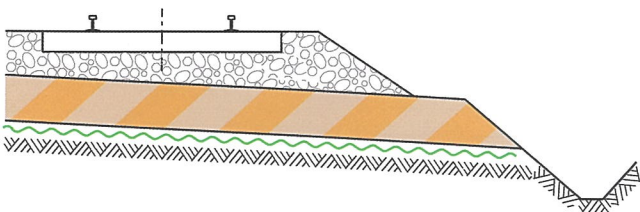

c) with 1 layer of composite

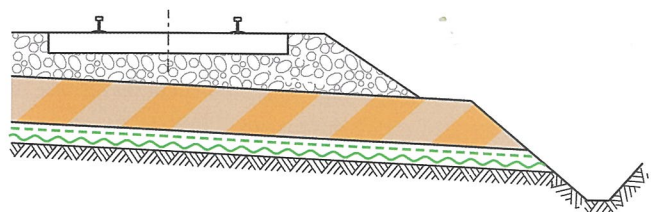

b) with 1 layer of geogrid

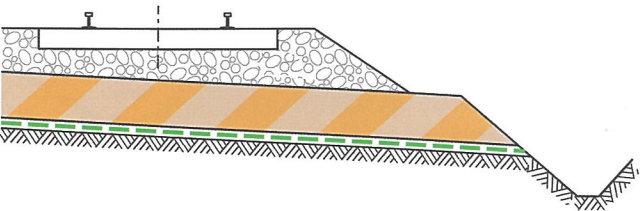

d) with several geosynthetic layers

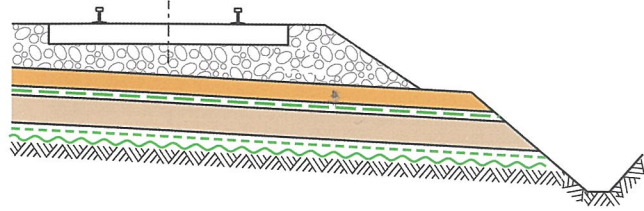



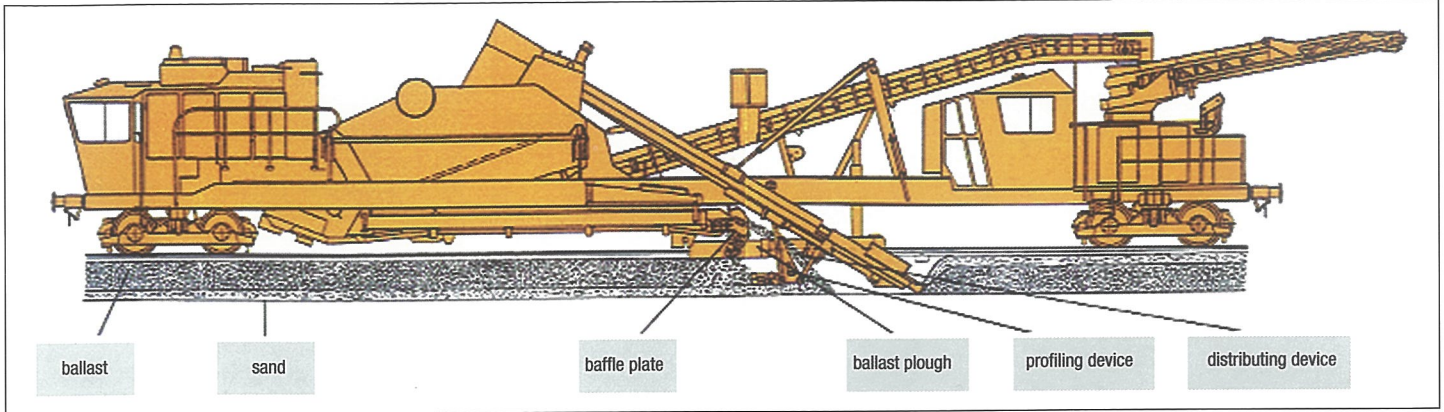

Above: Fig. 17: Diagram of a RM 61 machine used for laying gravel and sand.

Below: Fig. 18: Cross-section diagrams of the track formation showing the RM 61 stages of work.

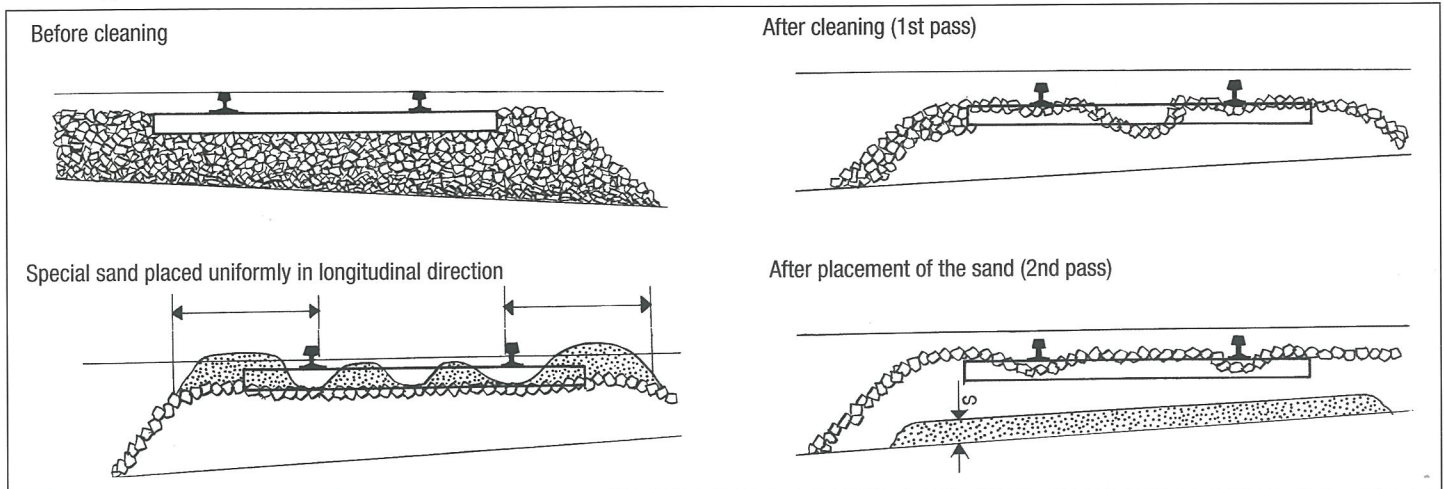

The technologies became more and more sophisticated, the construction machines had greater output and the recycling proportion from the ballast became even larger. From around 1960, based on existing examples, track maintenance machines and systems were developed that could install formation protective layers without removing the track.

At the end of 1960, a system developed by Plasser & Theurer, in conjunction with the RM 61 ballast bed cleaning machine, was able to place in two working passes a layer of gravel-sand around 15cm thick without removal of the track. Figures 17 and 18 show the machine and the stages of work. After the ballast cleaning, the gravel was distributed on

the ballast bed and, during the second pass of the machine, gravel and ballast was picked up, separated through screens and installed in layers. The layered structure of a FPL installed in this way around 1970 can be seen in Figure 19 after 35 years in service.

From 1983, the PM 200-1 was the first autonomous formation rehabilitation machine to go into service that removed the damaged subsoil and the ballast using an excavating chain, placed gravel brought in separately, as well as cleaned old ballast and new ballast and consolidated the FPL and ballast. This began a mechanical and constructional development which led to an increasingly sophisticated mechanisation, an increase in material

recycling and a rise in the quality of installation [13]. Initially, up to five stages of work using five different track maintenance machines were necessary to produce a multi-layer formation improvement without removal of the track, but today this can be done in one pass by one machine (Figure 20). The relaying outputs were raised continually and, at the same time, spoil, transport, construction time and the influence on traffic was clearly reduced. The material recycling and the quality of ballast and stone mixtures were further improved. The stages of development are explained in detail in [13].

Today, it is possible to select and apply the most suitable technical and mechanical solution depending upon the local geohydrological, geometric, ecological and operational conditions.

From the different technologies of road-based and track-based methods, there are varying conditions and requirements for installation, consolidation and quality control of the protective layer. Generally, it applies that both methods have to achieve and verify the same level of quality (density and load-bearing capacity) and the same service properties for the protective layer. But both methods of installation have very different characteristics with regard to the technological, scheduling and operational conditions [1, 14] that arise, particularly from the utilisation of the track under repair as the working and transporting path. No longitudinal construction of the track is needed and the weather factors are excluded during machine operation when using the on-track method.

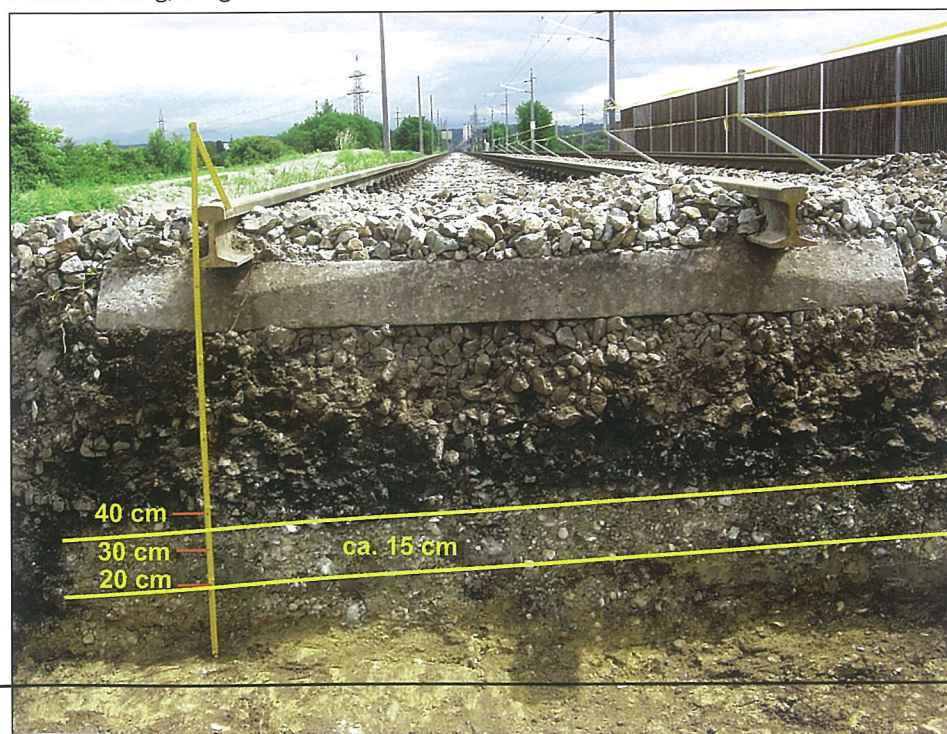
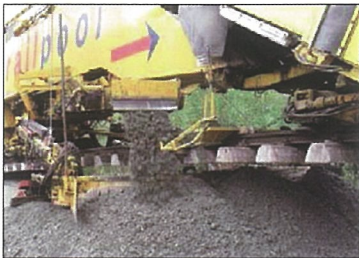

Fig. 19: Photograph showing an excavation during track renewal in 2005.



### On-track installation of protective layers

- Excavation of mixed zone and soil
- Completion of soil formation in height, crossfall and width
- Placement and consolidation of the trackbed layer
- Combination of trackbed layer with geosynthetics possible



### Outlook - development towards trackbed systems

In-depth investigations into the practical suitability [15], making special allowance for dynamic excitations, have shown that reinforced trackbed systems consisting of stone mixtures and geosynthetics have a higher stiffness and a better load-distributing effect and, therefore, reduce and equalise possible settlements. Track geometry and ride comfort are clearly improved even at higher travelling speeds. Additionally, thanks to their damping effect, the dynamic stresses under these reinforced trackbed systems are reduced. Therefore, the previously applied deeper earthwork measures for subsoil strengthening in the substructure and subsoil can in future be complemented and optimised by reinforced trackbed systems. This applies especially in combination with the installation of a higher elasticity in the track which shows a higher effect as a spring and damping element on stiffer trackbed systems.

These trackbed systems that reduce dynamic stresses can also be installed by road-based or track-based methods. Figure 21 shows a practical example of a trackbed system on a railway line with a soft layer in the subsoil fitted with linear transducers to verify the effect. Figure 22 gives a view of a geogrid layer being inserted by the PM 1000 which can install in one pass a four-layer trackbed system consisting of a composite geosynthetic on the bottom, a mechanically improved trackbed layer made up of recycled ballast and subsoil, on top of which a geogrid and a stone mixture are laid.

### Literary references

- [1] Göbel, C./Lieberenz, K.: Handbuch Erdbauwerke der Bahnen, Eurailpress, Hamburg, 2004.
- [2] Kipper, R./Lieberenz, K.: Influence of the substructure and the trackbed system on the track position, in: Railway Technical Review 3/2011, pp. 26-29.
- [3] Heyne, W.: Der Erdbau in seiner Anwendung auf Eisenbahnen und Strassen, Alfred Hölder, Vienna 1876.
- [4] Rziha, F.: Eisenbahn-Unter- und Oberbau, first to third volume, Druck und Verlag der K.-K. Hof- und Staatsbücherei, Vienna 1876.
- [5] Schau, A.: Der Eisenbahnbau, Verlag

Fig. 20: Overview of the processes of a formation rehabilitation machine.

- [7] Raab, R.: Erinnerung an die Entwicklung des Gleisunterbaues – Wege und Irrwege, in: Eisenbahntechnische Praxis 4/1980, pp. 34-37, 2/1981, pp. 33-38, 4/1981, pp. 34-37.
- [8] Richtlinien für die Entwässerung und Festigung der Erdbauten (Erdbaurichtlinien), DV 836, DB, 1.4.1957.
- [9] Vorschrift für Erdbauwerke (VE), DS 836, DB, 1.1.1985.
- [10] Fachbereichsstandard Eisenbahnunterbau, TGL 24756, draft September 1990.
- [11] Ausführungsbestimmungen (ABest) zur Vorschrift für Erdbauwerke DS 836, DR, 1.7.1991.
- [12] Erdbauwerke planen, bauen und instand halten, Ril 836, DB, 20.12.1999.
- [13] Riebold, K./Piereeder, F.: Gleisgebundene Unterbausanierungstechnologien, in: EIK 2010, pp. 31-44.
- [14] Hillig, J. et. al: Anforderungen an den gleisgebundenen Einbau von Schutzschichten, in: EIK 2004, pp. 109-123.
- [15] Kipper, R./Weisemann, U.: Wirkungsweise von mehrfach bewehrten Tragschichten - ein Erfahrungsbericht, presentation at Bautex 2010, Chemnitz, 28.10.2010.

von B. G. Teubner, Leipzig/Berlin 1911.  
 [6] Pfahnl, K.: Die Bahnerhaltung, Österreichische Bundesbahnen, Linz 1944.

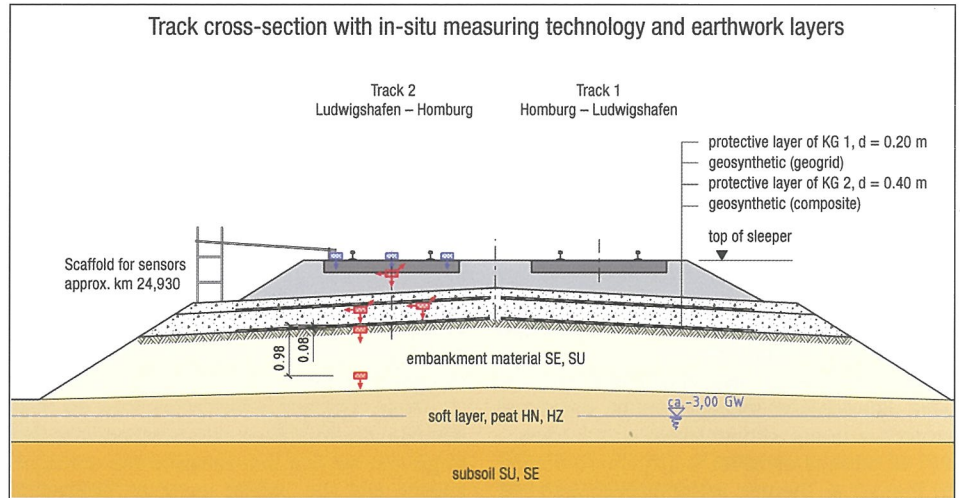

Above: Fig. 21: The reinforced trackbed system in cross section.

Below: Fig. 22: Installation of a trackbed layer with a geogrid.

